

8 7 6 5 4 3 2 1

F
E
D
C
B
A

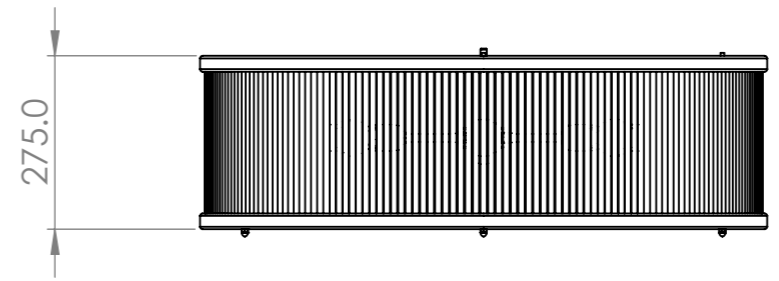

PART NUMBER	BODHRAN-900-275
DESCRIPTION	Acrylic Rod Drum 900mm dia 275mm high
LIGHT SOURCE	8 x E27 (ES) lamps (lamps not supplied)
WIRING	Mains powered.
SUSPENSION	3 catenary wires from a ceiling cap to clutches. Wires 3m as standard. min suspension height applys.
MATERIALS	Steel rings with frame welded into the top ring. Rings spaced with steel struts. Steel lighting rig in center. Steel parts powder coat painted. Acrylic tubes and acrylic dust guard.
WEIGHT (estimated)	15.1Kg

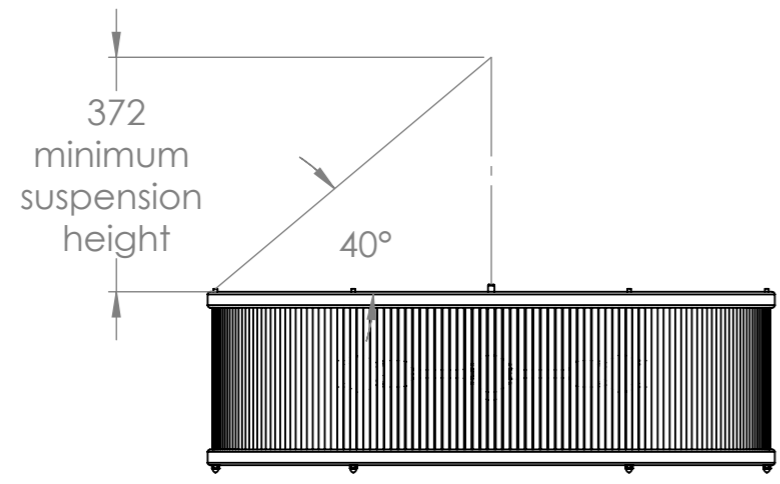
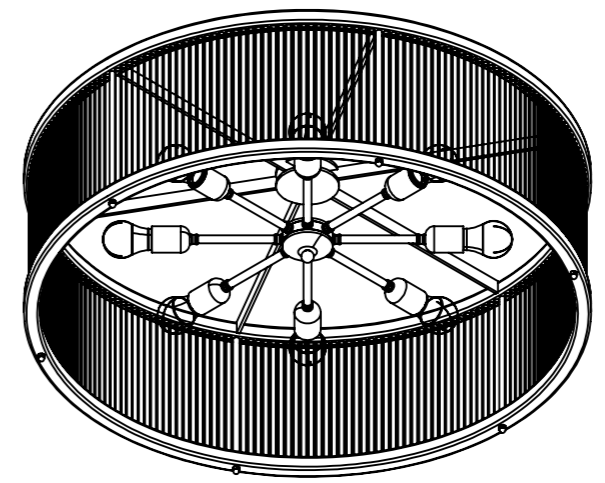
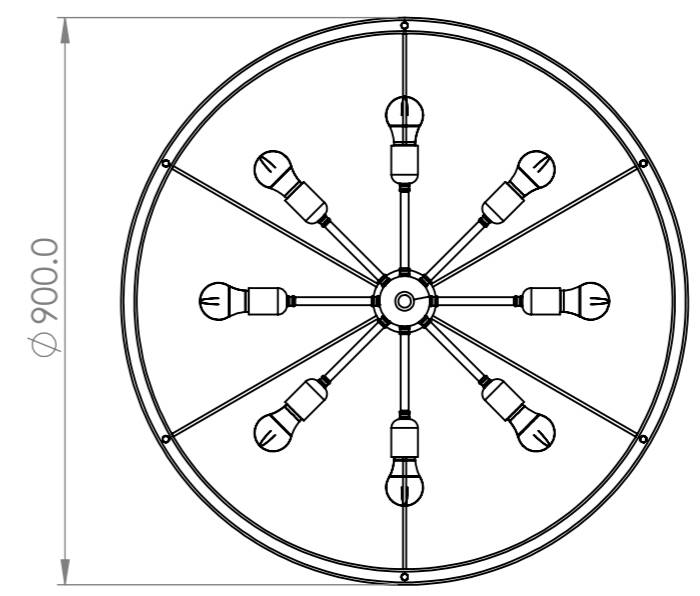

8 7 6 5 4 3 2 1

F
E
D
C
B
A